

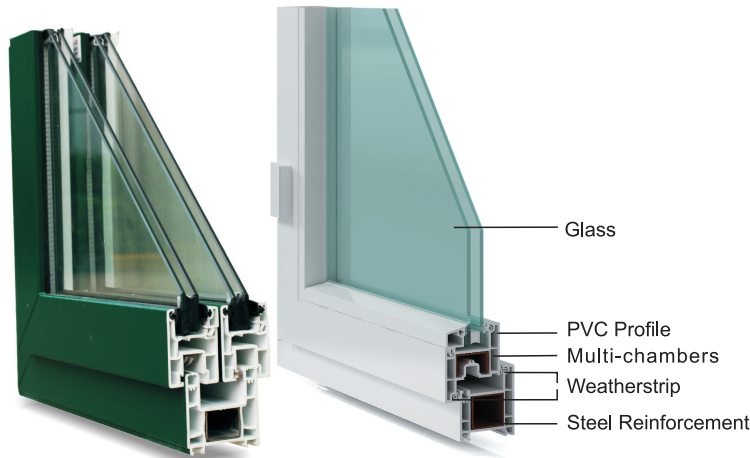

UPVC Windows and Doors Profile



Sliding Window

Casement Window

LESSO UPVC windows and doors Profile is made of the top quality materials PVC. It is designed and manufactured with strict standards, which assure that it can work under the temperature ranging from -50°C to 70°C , the welding angle is high tensile strength, the anti-aging is up to 6000h, the lifetime is more than 30 years.

Advantages of UPVC windows and doors Profile

Thermal Insulation and Energy Efficient

PVC windows and doors profile has a low thermal conductive, which can reduce the loss of energy. They are designed with multi-chambers which also reduce the transmission of heat.

Sound Insulation

The multi-chambers, welded corners and tight seals offer excellent sound insulation.

Water Tightness

PVC windows and doors profile absorbs water below 0.1%. Moreover the uniquely designed weep hole and weatherstrip in the meeting rail provide water resistance proof.

Weather Resistance

When PVC windows and doors are exposed in scorching sun, storms, dryness, high humidity or other extreme weather change, They do not rot, corrode nor warp. Even after many years, the windows and doors are still attractive, perfectly tight and working well.

Corrosion Resistance

PVC windows and door profile is free from the attack of acids, alkalis, waste gases, and salts.

Fire Resistance

PVC materials used in windows and doors are difficult to ignite and do not support or enhance accidental fires unlike their timber counterparts.

Electricity Insulation

PVC windows and doors profile have a high electricity insulation.

Strength and Security

All main PVC profiles are reinforced with steel, providing a high level of security.

Maintenance Free

The closed smooth surface of PVC profiles ensures ease of clean by using gentle household detergent dissolved in water. They are also available with a foil coating in different colors, so you do not need to paint it

Environmental Friendly

PVC windows and doors can be fully recycled.

LESSO UPVC Profile Standard

Composite	DIN 7748-PVC-U EDPL	080—35—28
Desity	DIN 53479/ISO1183	1.46g/cm ³
-40°C Dropping Impact Testing	DIN 53453/ISO 179 BS7413	good
Impact Strength (DIN50014)	DIN 53453/ISO 179 BS7413	> 30KJ/m ²
Ball Pressure Hardness(30s)	DIN ISO 239 T1 ISO.750239	100N/m m ²
Tensile Strength	DIN 53455/ISO527 BS7413	> 40N/m m ²
Modulus Of Elasticity	DIN 53457	> 2200 N/m m ²
Vicat VST/B	DIN ISO.306	More 83°C
ISO R 75/A	DIN 53461/ISO868	More 69°C
Thermal Expansion Coefficient	Expansion Measure Meter	$0.8 \times 10^{-4}K^{-1}$
Thermal Transmission	DIN 52612	0.16W/m ² K
Resistance for Electricity	DIN VDE 0303 T3	$10^{16} \Omega \text{ cm}$
Relative Permittivity	DIN 53483	With 50Hz, 3.3 With 10 ⁶ Hz, 2.9
Fire Resistance	DIN4102	Flame Resistant
Stability	Radiation : 8.0GJ/sqm	
RAL-GZ 716/1	More Than 4 Level in DIN ISO105-A03	
Weathering Aging	With Radiation 8.0 GJ/sqm	
Resistance for Rust	DIN 8061 BbI1 ISO/TR 10358 Resistance for insect, alkali , acid, salt, sea water, gasoline, oil, cement and other radioactive substance	

EITI WINDOWS &
DOORS SYSTEM



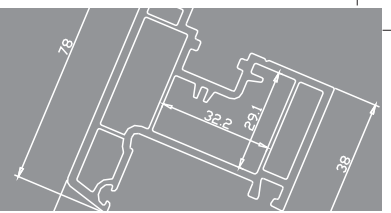

60mm Casement Window Series

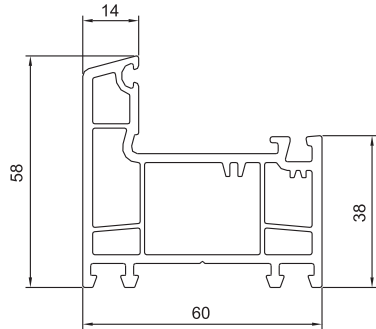

Description	60 Casement Frame
Part Number	PC60-1
Weight	1.020 kg/m
Quantity	6 pieces/bag

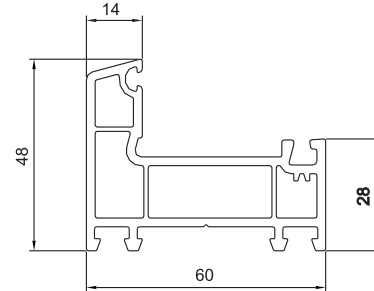

Description	60 Small Casement Frame
Part Number	PC60-2
Weight	0.848 kg/m
Quantity	6 pieces/bag

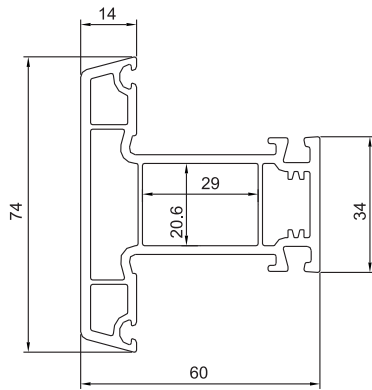

Description	60 Casement Mullion
Part Number	PC60-3
Weight	1.100 kg/m
Quantity	4 pieces/bag

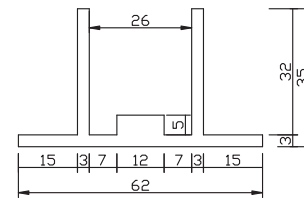

Description	Mullion Connector 1
Part Number	LC8-1
Weight	
Quantity	

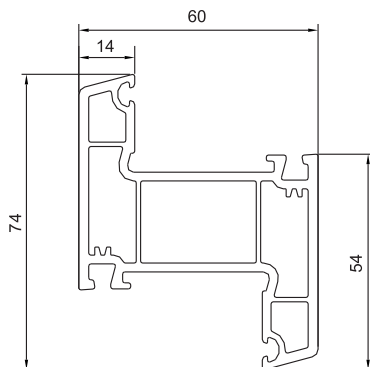

Description	60 Z Mullion
Part Number	PC60-4
Weight	1.100 kg/m
Quantity	4 pieces/bag

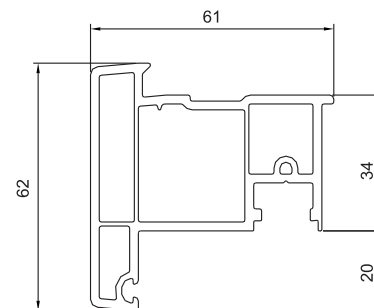

Description	60 Movable Mullion
Part Number	PC60-5
Weight	0.930 kg/m
Quantity	6 pieces/bag

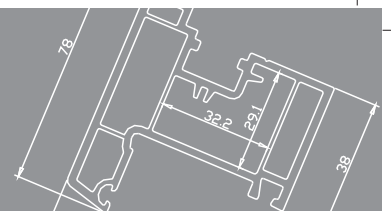

60mm Casement Window Series

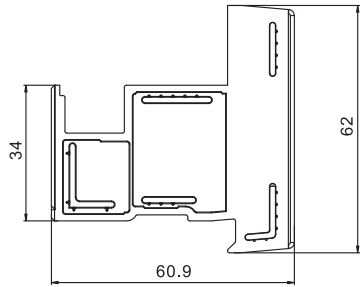

Description	60 movable mullion end cap
Part Number	PC60-FTDG-1-L
Weight	
Quantity	

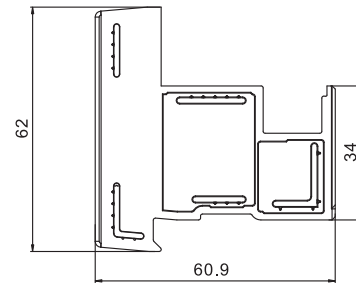

Description	60 movable mullion end cap
Part Number	PC60-FTDG-1-R
Weight	
Quantity	

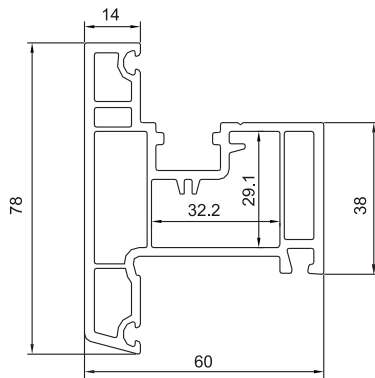

Description	60 Outward Sash
Part Number	PC60-6
Weight	1.220 kg/m
Quantity	4 pieces/bag

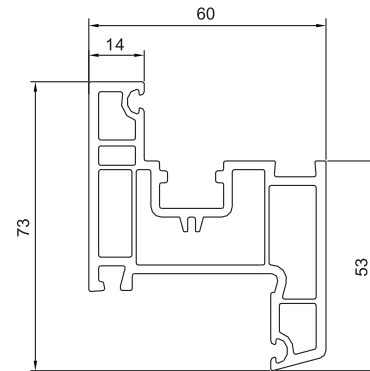

Description	60 Inward Sash
Part Number	PC60-7
Weight	1.195 kg/m
Quantity	4 pieces/bag

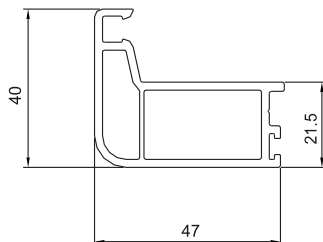

Description	60 Casement Insect Screen
Part Number	PC60-8
Weight	0.520 kg/m
Quantity	12 pieces/bag

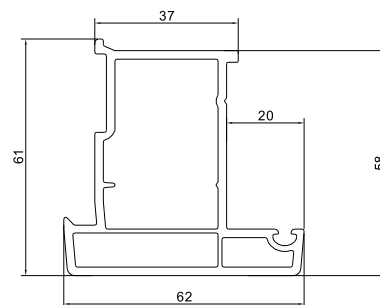

Description	60 Movable Mullion II
Part Number	PC60-18
Weight	0.84kg/m
Quantity	4 pieces/bag

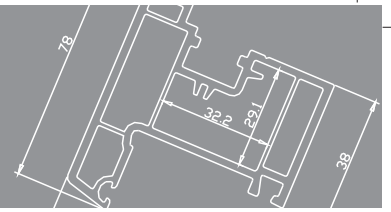

60mm Casement Window Series

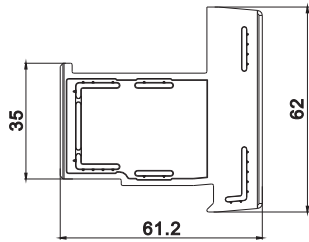

Description	60 movable mullion end cap
Part Number	PC60-FTDG-2-L
Weight	
Quantity	

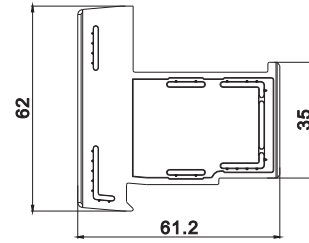

Description	60 movable mullion end cap
Part Number	PC60-FTDG-2-R
Weight	
Quantity	

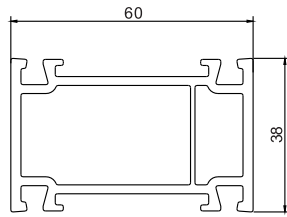

Description	60 Universal Frame
Part Number	PC60-20
Weight	0.81kg/m
Quantity	4 pieces/bag

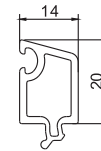

Description	60 Universal Glass Bead
Part Number	PC60-19
Weight	0.17kg/m
Quantity	30 pieces/bag

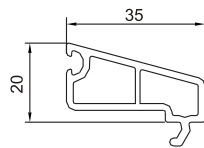

Description	60 Single Glazing Bead
Part Number	PC60-9
Weight	0.280 kg/m
Quantity	20 pieces/bag

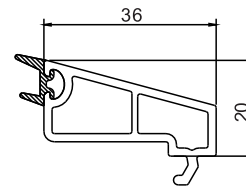

Description	60 Single Glazing Bead (co-extrusion with gasket)
Part Number	CPC60-9
Weight	0.305kg/m
Quantity	20 pieces/bag

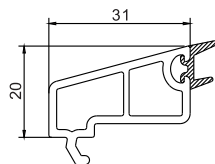

Description	Co-extrusion 60 Casement Single Glass Bead II (8-10.38mm)
Part Number	CPC60-21
Weight	0.31kg/m
Quantity	20 pieces/bag

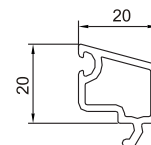

Description	60 Double Glazing Bead
Part Number	PC60-10
Weight	0.200 kg/m
Quantity	30 pieces/bag

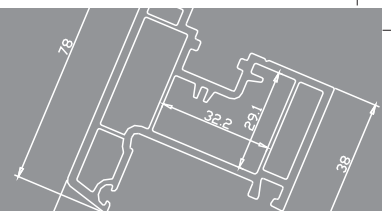

60mm Casement Window Series

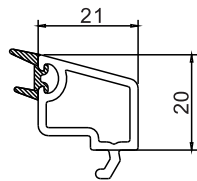

Description	60 21mm Double Glazing Bead (co-extrusion with gasket)
Part Number	CPC60-10
Weight	0.225kg/m
Quantity	30 pieces/bag

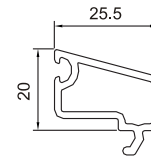

Description	60 Double Glazing Bead (25mm)
Part Number	PC60-11
Weight	0.230 kg/m
Quantity	30 pieces/bag

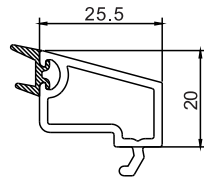

Description	60 25mm Double Glazing Bead (co-extrusion with gasket)
Part Number	CPC60-11
Weight	0.265kg/m
Quantity	30 pieces/bag

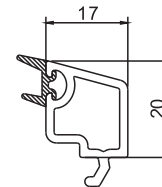

Description	60 17mm Triple Glazing Bead (co-extrusion with gasket)
Part Number	CPC60-12
Weight	0.205kg/m
Quantity	30 pieces/bag

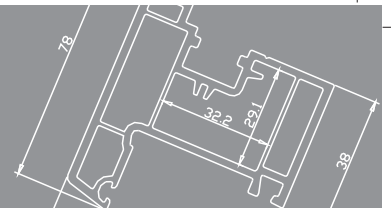

60mm Casement Window Series

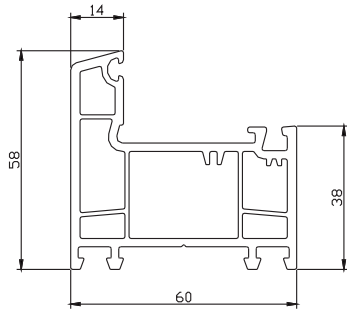

Description	60 Casement Frame B
Part Number	● PC60-1B
Weight	1.050 kg/m
Quantity	6 pieces/bag

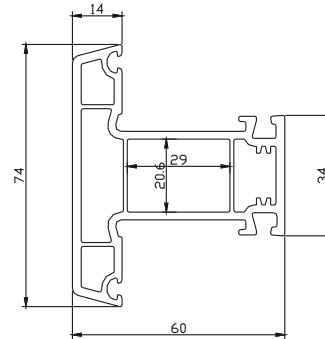

Description	60 Casement Mullion B
Part Number	● PC60-3B
Weight	1.150 kg/m
Quantity	4 pieces/bag

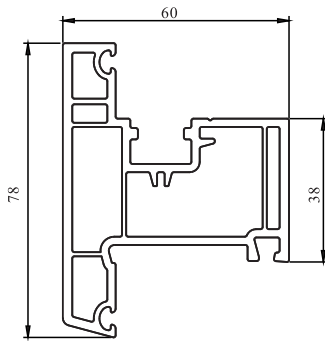

Description	60 Outward Sash B
Part Number	● PC60-6B
Weight	1.280 kg/m
Quantity	4 pieces/bag

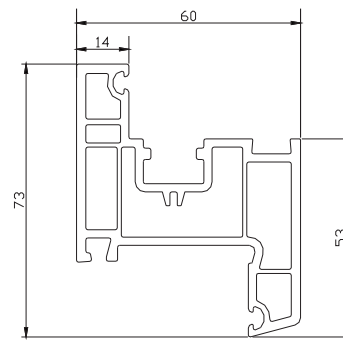

Description	60 Inward Sash B
Part Number	● PC60-7B
Weight	1.240 kg/m
Quantity	4 pieces/bag

Note: Items with mark “●” (B series) means more wall thickness.

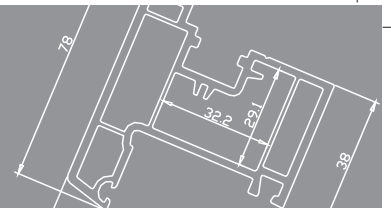

Steel Reinforcement

	<table border="1"> <tr> <td>Size</td> <td>ST28×21.5</td> </tr> <tr> <td>Suitable Profile</td> <td>PC60-1, PC60-1B</td> </tr> </table>	Size	ST28×21.5	Suitable Profile	PC60-1, PC60-1B
Size	ST28×21.5				
Suitable Profile	PC60-1, PC60-1B				
	<table border="1"> <tr> <td>Size</td> <td>ST30×10</td> </tr> <tr> <td>Suitable Profile</td> <td>PC60-2</td> </tr> </table>	Size	ST30×10	Suitable Profile	PC60-2
Size	ST30×10				
Suitable Profile	PC60-2				
	<table border="1"> <tr> <td>Size</td> <td>ST27×17</td> </tr> <tr> <td>Suitable Profile</td> <td>PC60-3, PC60-4, PC60-3B</td> </tr> </table>	Size	ST27×17	Suitable Profile	PC60-3, PC60-4, PC60-3B
Size	ST27×17				
Suitable Profile	PC60-3, PC60-4, PC60-3B				
	<table border="1"> <tr> <td>Size</td> <td>St25×26</td> </tr> <tr> <td>Suitable Profile</td> <td>PC60-5</td> </tr> </table>	Size	St25×26	Suitable Profile	PC60-5
Size	St25×26				
Suitable Profile	PC60-5				
	<table border="1"> <tr> <td>Size</td> <td>ST31×27.5</td> </tr> <tr> <td>Suitable Profile</td> <td>PC60-6, PC60-6B</td> </tr> </table>	Size	ST31×27.5	Suitable Profile	PC60-6, PC60-6B
Size	ST31×27.5				
Suitable Profile	PC60-6, PC60-6B				
	<table border="1"> <tr> <td>Size</td> <td>ST31.5×20.5</td> </tr> <tr> <td>Suitable Profile</td> <td>PC60-7, PC60-7B</td> </tr> </table>	Size	ST31.5×20.5	Suitable Profile	PC60-7, PC60-7B
Size	ST31.5×20.5				
Suitable Profile	PC60-7, PC60-7B				
	<table border="1"> <tr> <td>Size</td> <td>ST28×15.5</td> </tr> <tr> <td>Suitable Profile</td> <td>PC60-8</td> </tr> </table>	Size	ST28×15.5	Suitable Profile	PC60-8
Size	ST28×15.5				
Suitable Profile	PC60-8				

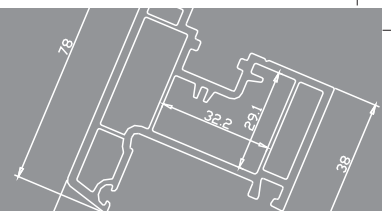

Assembly Section of 60mm Casement
Outward Window Series

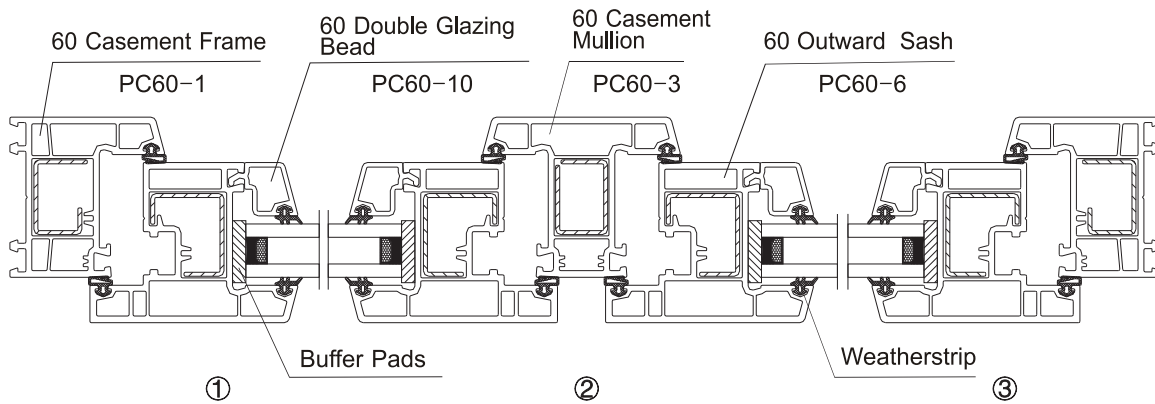
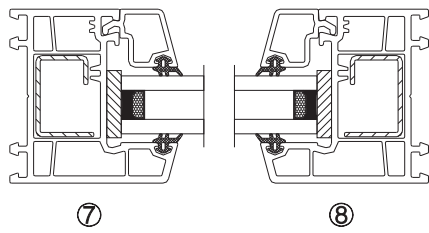
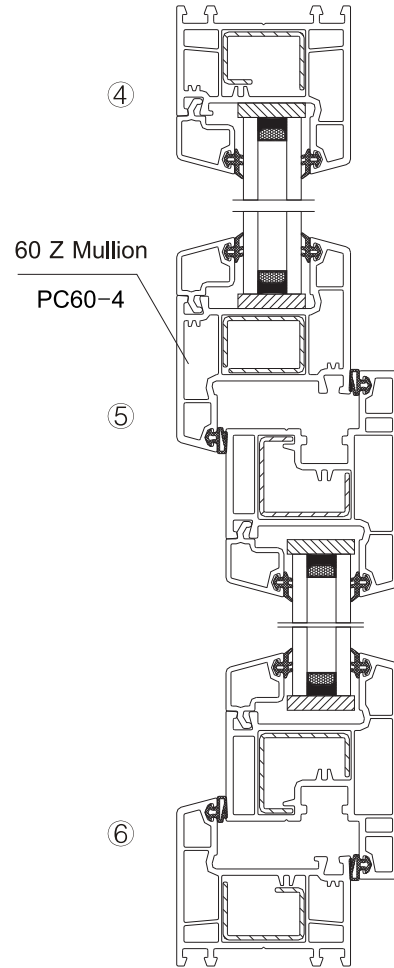
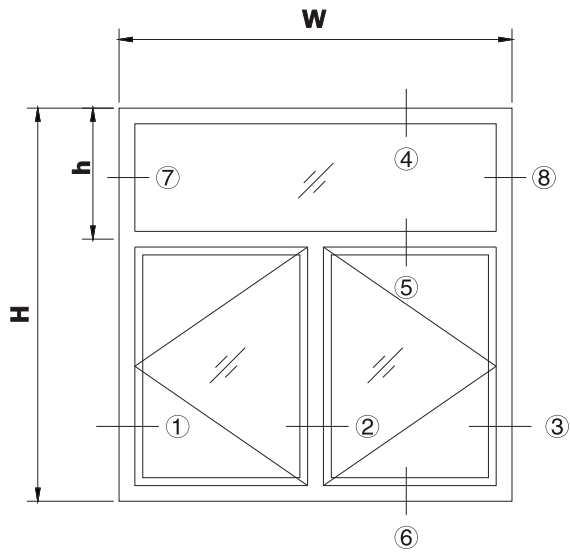

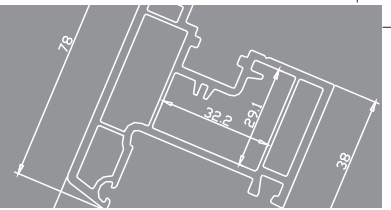

Profile Utilization Rate of 60mm Casement Outward Window Series

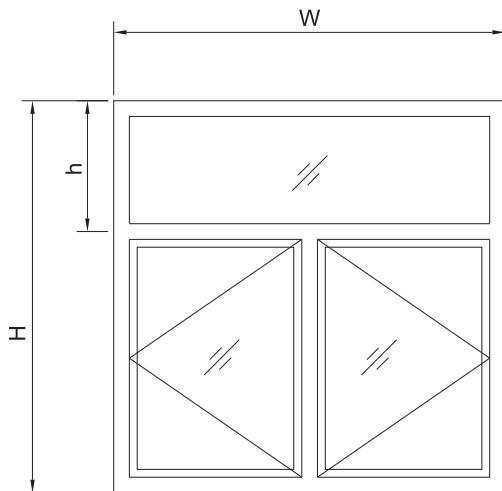

Window Type: 60 Casement Double Outward Window Series with Transom

Masonry Opening: 1500mm × 1500mm

Window Size: 1470mm × 1470mm

Accessories: Double Glazing, Transmission Rod

Description	Part Number	Used Size (mm)	Quantity (Piece)	Length (m)	Weight (kg/m)	Subtotal (kg)
Casement Frame	PC60-1	506	2	1.012	1.020	6.034
		976	2	1.952		
		1476	2	2.952		
Mullion	PC60-3	1029	1	1.029	1.100	2.791
Z Mullion	PC60-4	1508	1	1.508		
Outward Sash	PC60-6	702	4	2.808	1.220	7.998
		937	4	3.748		
Transom Frame Bead	PC60-10	1394	2	2.788	0.200	1.852
		445	2	0.890		
Sash Bead	PC60-10	580	4	2.320		
		815	4	3.260		
Total Weight/Window (kg)						18.675
Profile Utilization Rate (m²/t)						120.48

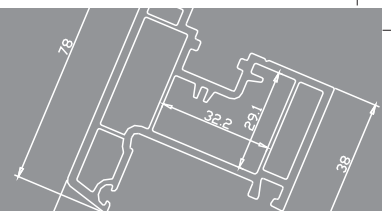

60mm Casement Door Series

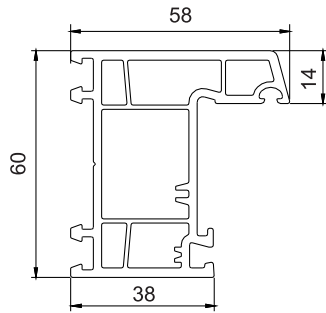

Description	60 Casement Frame
Part Number	PC60-1
Weight	1.020 kg/m
Quantity	6 pieces/bag

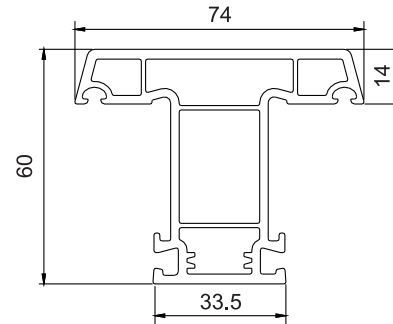

Description	60 Casement Mullion
Part Number	PC60-3
Weight	1.100 kg/m
Quantity	4 pieces/bag

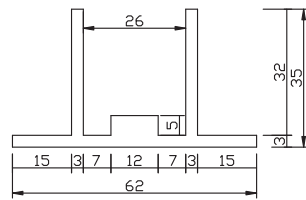

Description	Mullion Connector 1
Part Number	LC8-1
Weight	
Quantity	

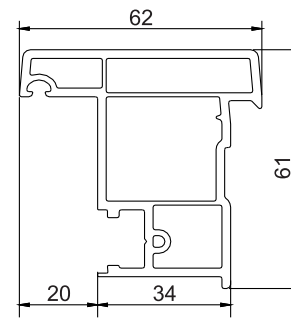

Description	60 Movable Mullion
Part Number	PC60-5
Weight	0.930 kg/m
Quantity	6 pieces/bag

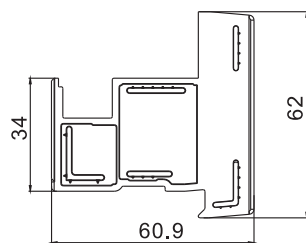

Description	60 movable mullion end cap
Part Number	PC60-FTDG-1-L
Weight	
Quantity	

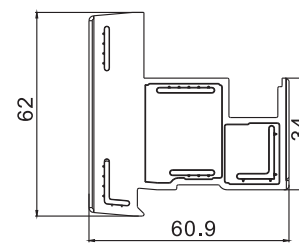

Description	60 movable mullion end cap
Part Number	PC60-FTDG-1-R
Weight	
Quantity	

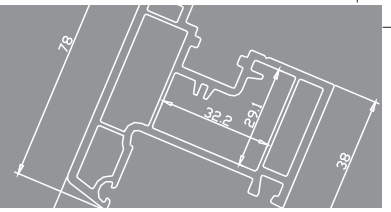

60mm Casement Door Series

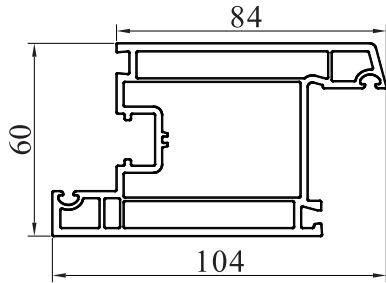

Description	60 Inward Door Sash
Part Number	PM60-1
Weight	1.480kg/m
Quantity	4pieces/bag

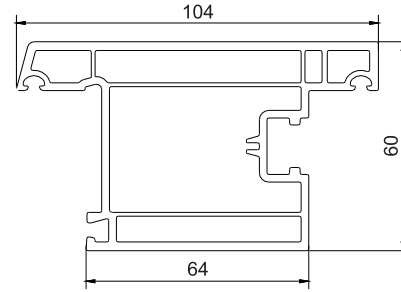

Description	60 Outward Door Sash
Part Number	PM60-2
Weight	1.483 kg/m
Quantity	4 pieces/bag

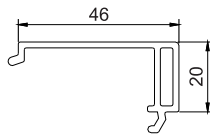

Description	60 Blinds for Shutter Window
Part Number	PM60-4
Weight	0.250 kg/m
Quantity	20 pieces/bag

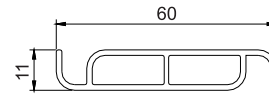

Description	60 Bead for Shutter Window
Part Number	PM60-5
Weight	0.313 kg/m
Quantity	20 pieces/bag

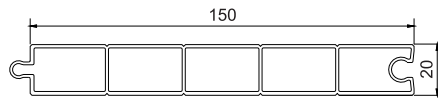

Description	60 Door Panel
Part Number	PM60-3
Weight	0.880 kg/m
Quantity	6 pieces/bag

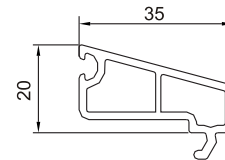

Description	60 Single Glazing Bead
Part Number	PC60-9
Weight	0.280 kg/m
Quantity	20 pieces/bag

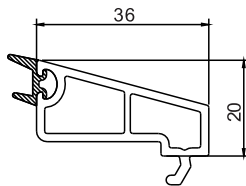

Description	60 Single Glazing Bead (co-extrusion with gasket)
Part Number	CPC60-9
Weight	0.305kg/m
Quantity	20 pieces/bag

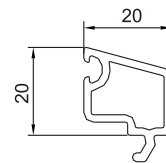

Description	60 Double Glazing Bead
Part Number	PC60-10
Weight	0.200 kg/m
Quantity	30 pieces/bag

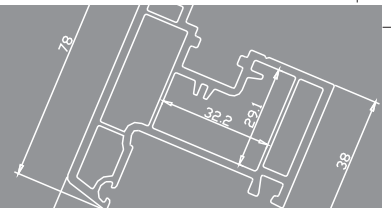

60mm Casement Door Series

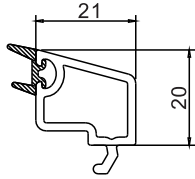

Description	60 21mm Double Glazing Bead (co-extrusion with gasket)
Part Number	CPC60-10
Weight	0.225kg/m
Quantity	30 pieces/bag

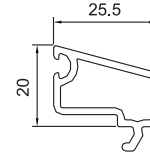

Description	60 Double Glazing Bead (25mm)
Part Number	PC60-11
Weight	0.230 kg/m
Quantity	30 pieces/bag

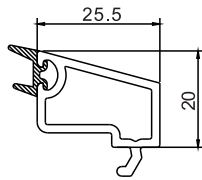

Description	60 25mm Double Glazing Bead (co-extrusion with gasket)
Part Number	CPC60-11
Weight	0.265kg/m
Quantity	30 pieces/bag

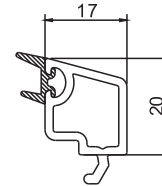

Description	60 17mm Triple Glazing Bead (co-extrusion with gasket)
Part Number	CPC60-12
Weight	0.205kg/m
Quantity	30 pieces/bag

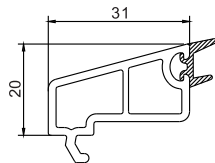

Description	Co-extrusion 60 Casement Single Glass Bead II (8-10.38mm)
Part Number	CPC60-21
Weight	0.31kg/m
Quantity	20 pieces/bag

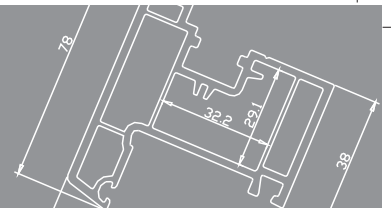

60mm Casemnt Door Series
Profile A Series

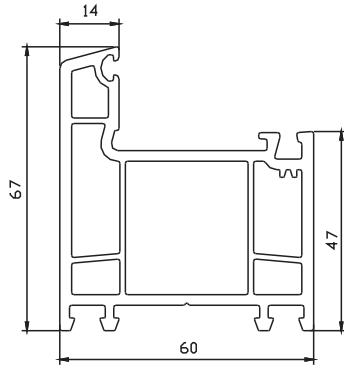

Description	60 Casement Frame A
Part Number	● PC60-1A
Weight	1.240 kg/m
Quantity	6 pieces/bag

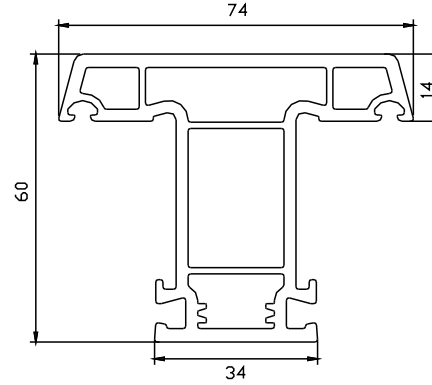

Description	60 Casement Mullion A
Part Number	● PC60-3A
Weight	1.220 kg/m
Quantity	4 pieces/bag

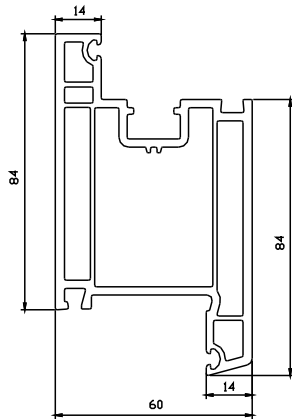

Description	60 Inward Sash A
Part Number	● PM60-1A
Weight	1.710 kg/m
Quantity	4 pieces/bag

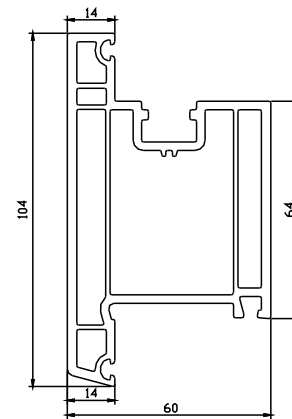

Description	60 Outward Sash A
Part Number	● PM60-2A
Weight	1.700 kg/m
Quantity	4 pieces/bag

Note: ① Items with mark “●” (A series) means more wall thickness.
 ② 60mm door series A using same inward/outward door sash as standard series.

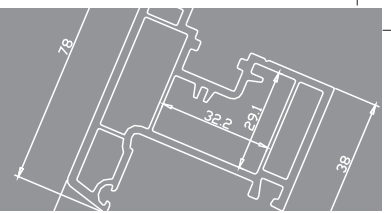

Steel Reinforcement

Size	ST28×21.5
Suitable Profile	PC60-1, PC60-1A

Size	ST27×17
Suitable Profile	PC60-3, PC60-3A

Size	ST25×26
Suitable Profile	PC60-5

Size	ST52.5×34.5
Suitable Profile	PM60-1 PM60-2 PM60-1A PM60-2A

Size	ST28×30
Suitable Profile	PC60-1, PC60-1A

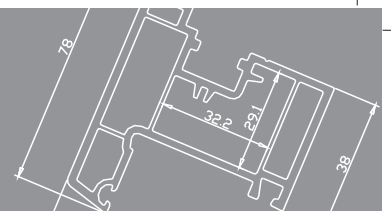

Assembly Section of 60mm Window & Door Series

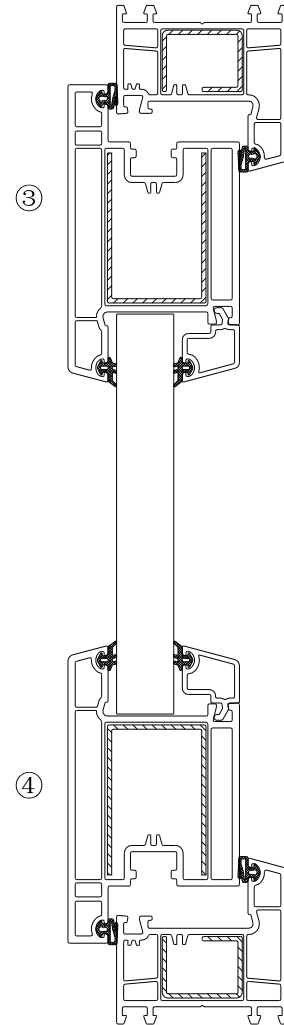
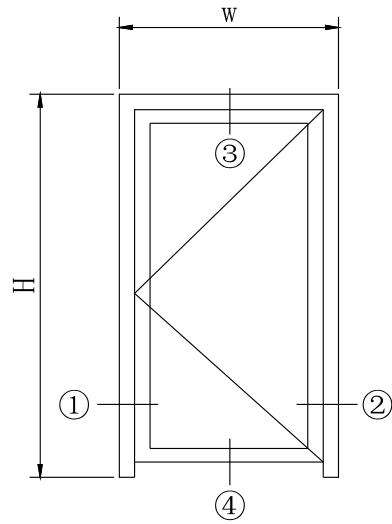

Assembly Drawing of Door Panel

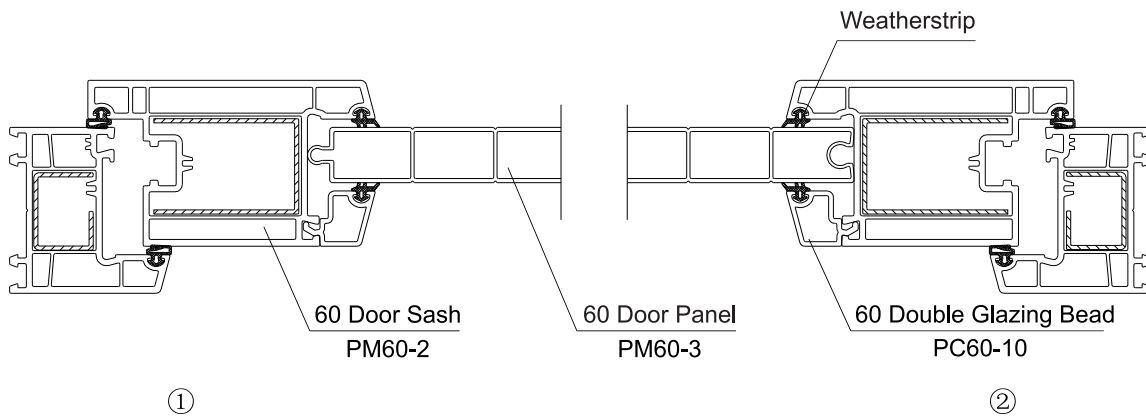

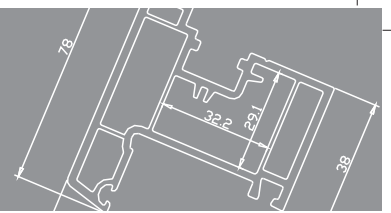

80mm Casement Door Series

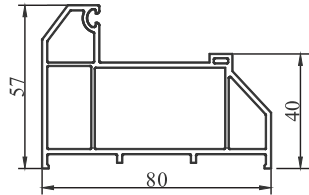

Description	80 Door Frame
Part Number	PM80-1
Weight	0.920kg/m
Quantity	4pieces/bag

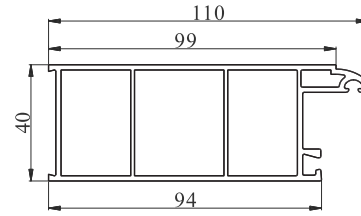

Description	80 Door Sash
Part Number	PM80-2
Weight	1.055kg/m
Quantity	4pieces/bag

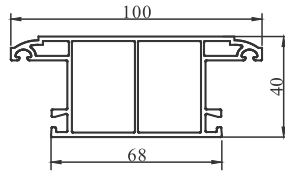

Description	80 Door Mullion(big)
Part Number	PM80-3
Weight	0.950kg/m
Quantity	4pieces/bag

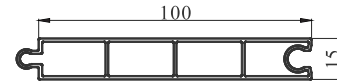

Description	80 Door Panel
Part Number	PM80-4
Weight	0.565kg/m
Quantity	8pieces/bag

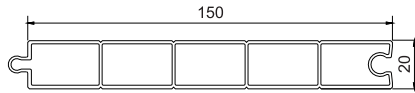

Description	60 Door Panel
Part Number	PM60-3
Weight	0.880 kg/m
Quantity	6 pieces/bag

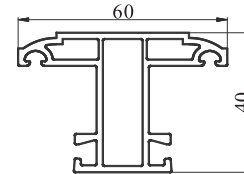

Description	80 Door Mullion(small)
Part Number	PM80-5
Weight	0.660kg/m
Quantity	8pieces/bag

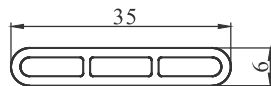

Description	80 Bead for Shutter Window
Part Number	PM80-6
Weight	0.175Kg/m
Quantity	20pieces/bag

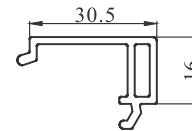

Description	80 Blinds for Shutter Window
Part Number	PM80-7
Weight	0.225kg/m
Quantity	20pieces/bag

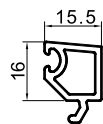

Description	60 Double Glazing Bead (15mm)
Part Number	TC60-13
Weight	0.165kg/m
Quantity	30 pieces/bag



Description	80 Double Glazing Bead
Part Number	TC80-13
Weight	0.117 kg/m
Quantity	40 pieces/bag

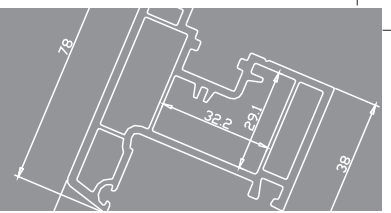

80mm Casement Door Series

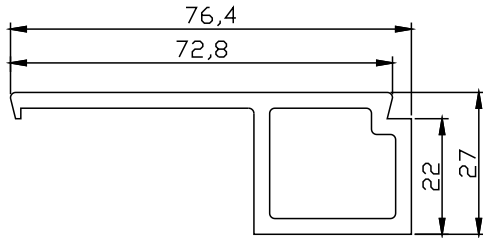

Description	80mm Casement Door Profile
Part Number	PM80-11
Weight	0.160 kg/m
Quantity	30 pieces/bag

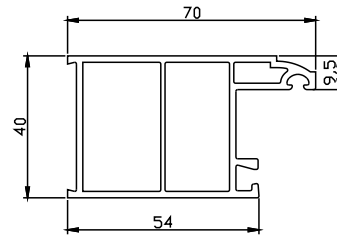

Description	80 Small Door Sash
Part Number	PM80-10
Weight	0.720 kg/m
Quantity	6 pieces/bag

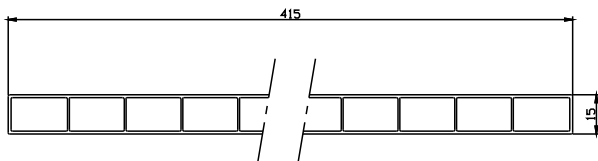

Description	415 Door Panel
Part Number	PM80-8
Weight	1.850 kg/m
Quantity	8 pieces/bag

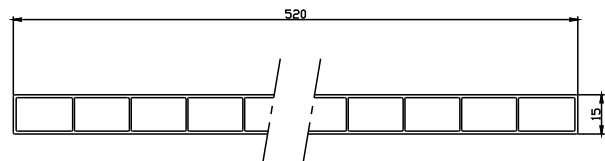

Description	520 Door Panel
Part Number	PM80-9
Weight	2.350 kg/m
Quantity	6 pieces/bag

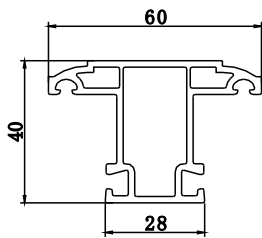

Description	80 Small Door Mullion II
Part Number	PM80-5 II
Weight	0.660 kg/m
Quantity	8 pieces/bag

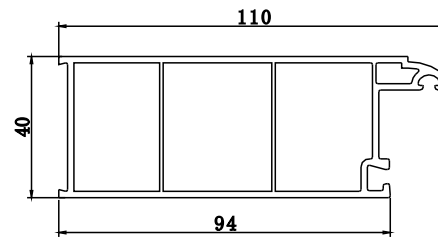

Description	80 Big Door Sash II
Part Number	PM80-2 II
Weight	0.920 kg/m
Quantity	4 pieces/bag

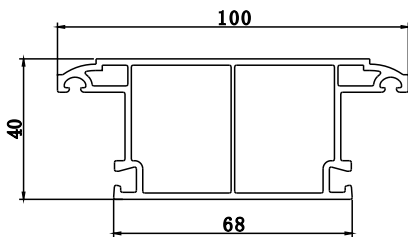

Description	80 Door Big Mullion II
Part Number	PM80-3 II
Weight	0.950 kg/m
Quantity	4 pieces/bag

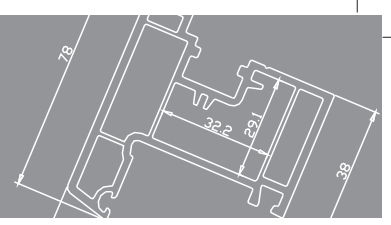

Assembly Section of 80mm Window & Door Series

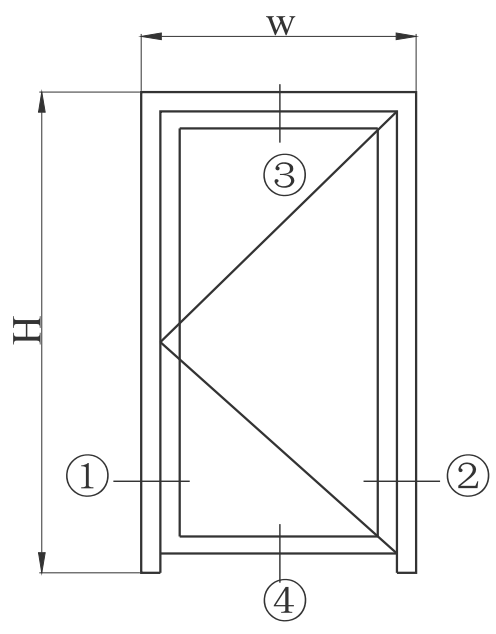

Drawing for Door Panel Assembly

